



49 - Department of Health and Social Services

Organizational Charts

Contents

49 - Department of Health and Social Services.....	1
Contents.....	2
Deputy Minister.....	3
ADM, Health Programs.....	4
Director, Seniors & Cont Care.....	5
Dir, Territorial Health Serv.....	6
Director, Mental Wellness and.....	7
ADM, Corporate Services.....	8
Director, Infrastructure Plann.....	9
Dir. Health Services Admin.....	10
Chief Information Officer.....	11
Dir Cultural Safety Anti-Racis.....	12
Director, Abo Hlth & Comm Well.....	13
Mgr, Soc Det, Pub Part & Innov.....	14
Territorial Exec Dir, Child & Family Services.....	15
Chief Public Health Officer.....	16
Director, Population Health.....	17
ADM Finance, Policy & Planning.....	18
Director, Finance.....	19
Director, Policy, Leg & Comm.....	20
Manager, Policy & Legislation.....	21
Dir., Corp Planning, Reporting.....	22

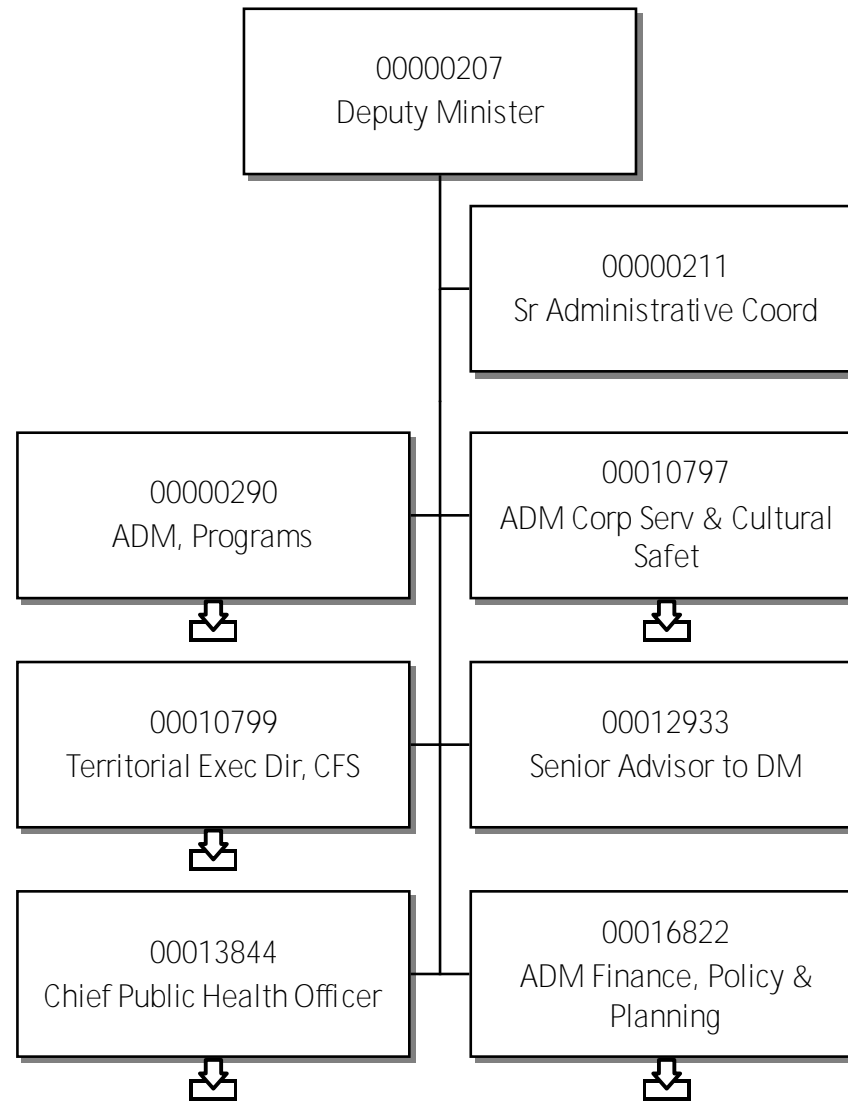

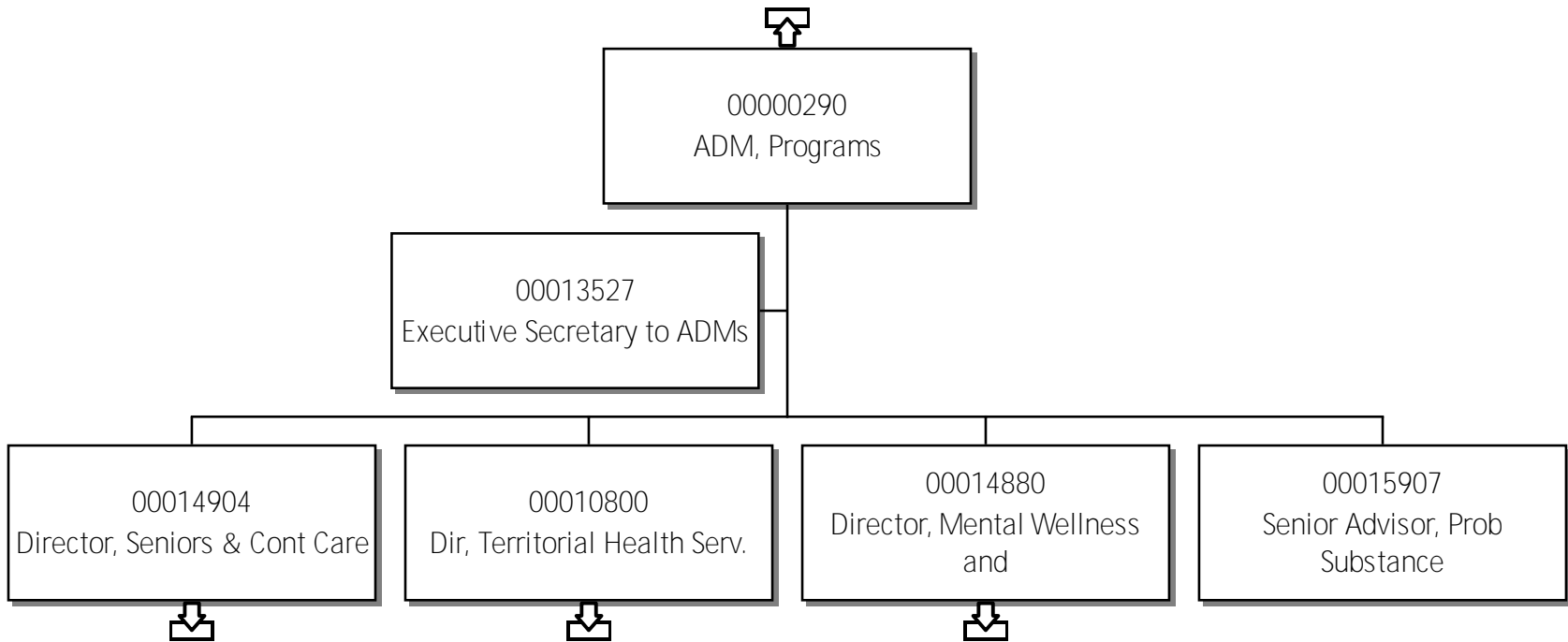

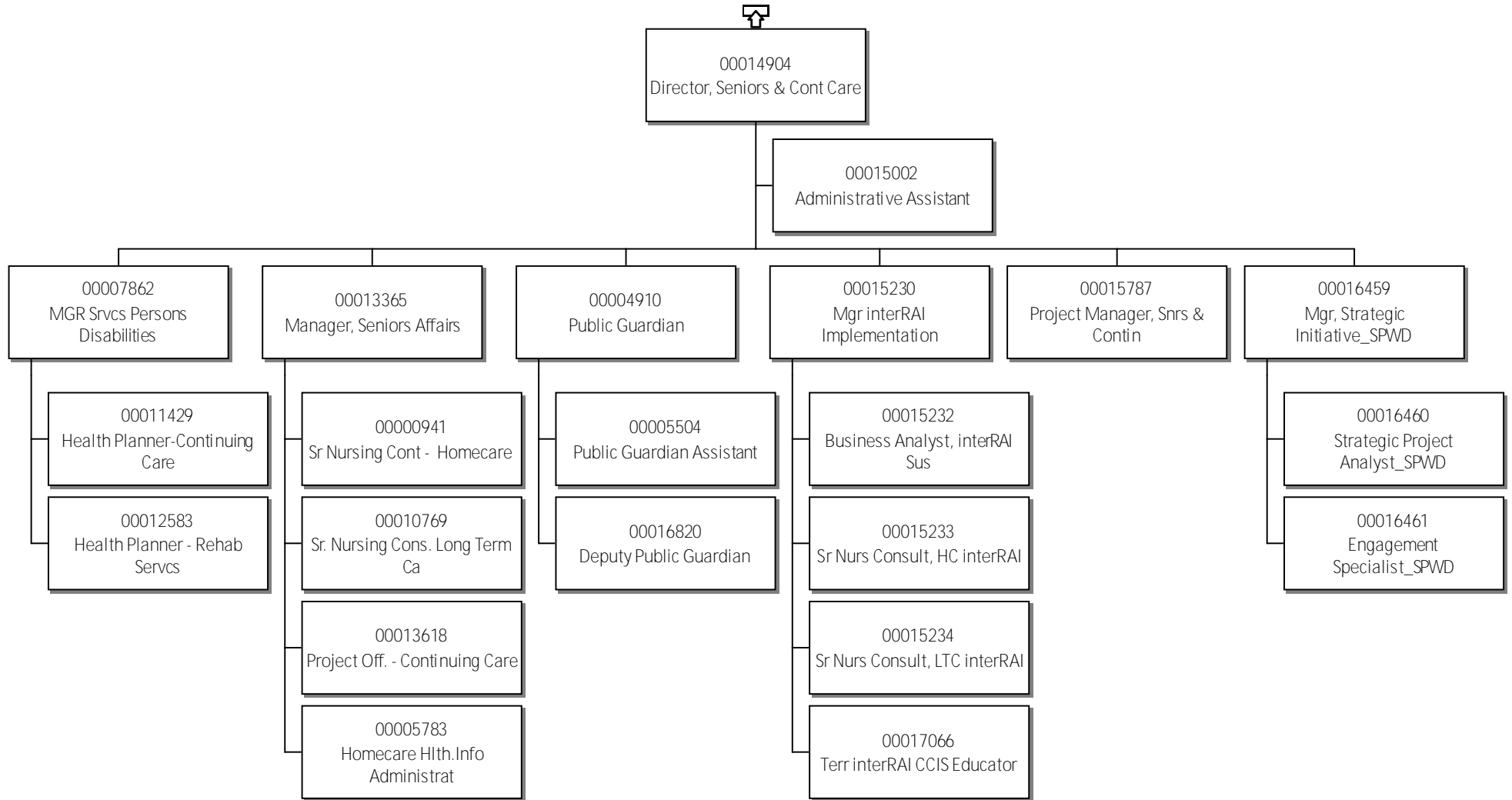

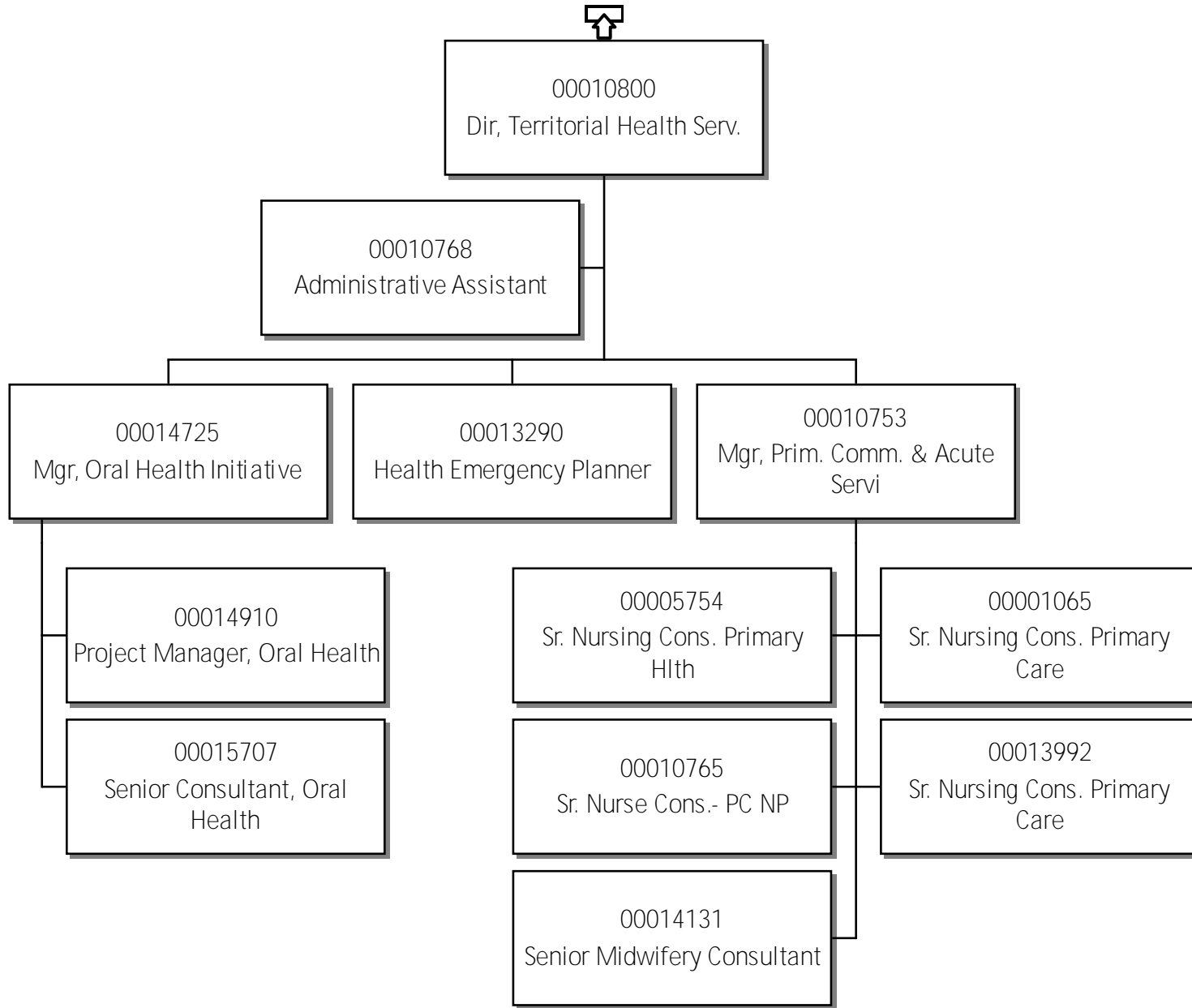

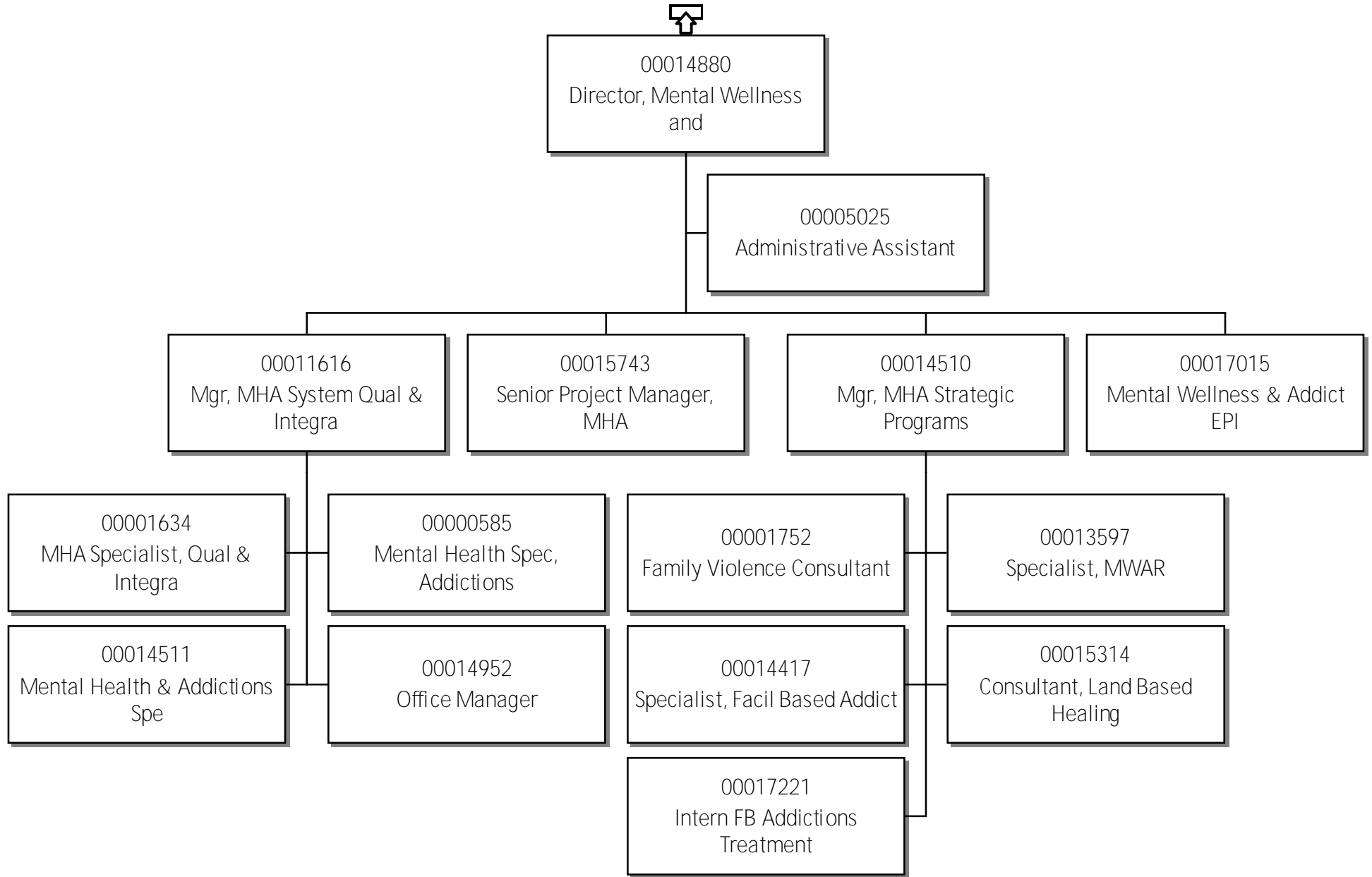

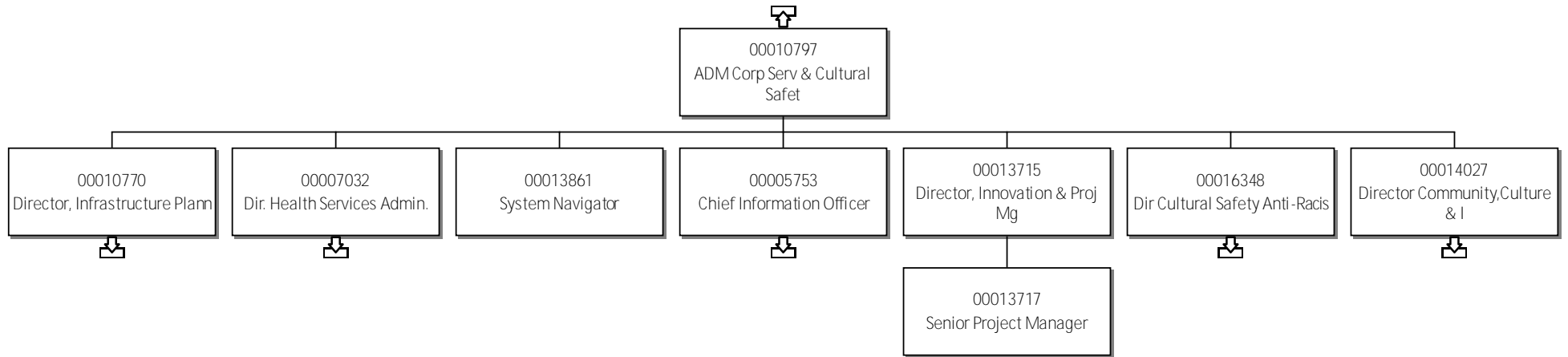

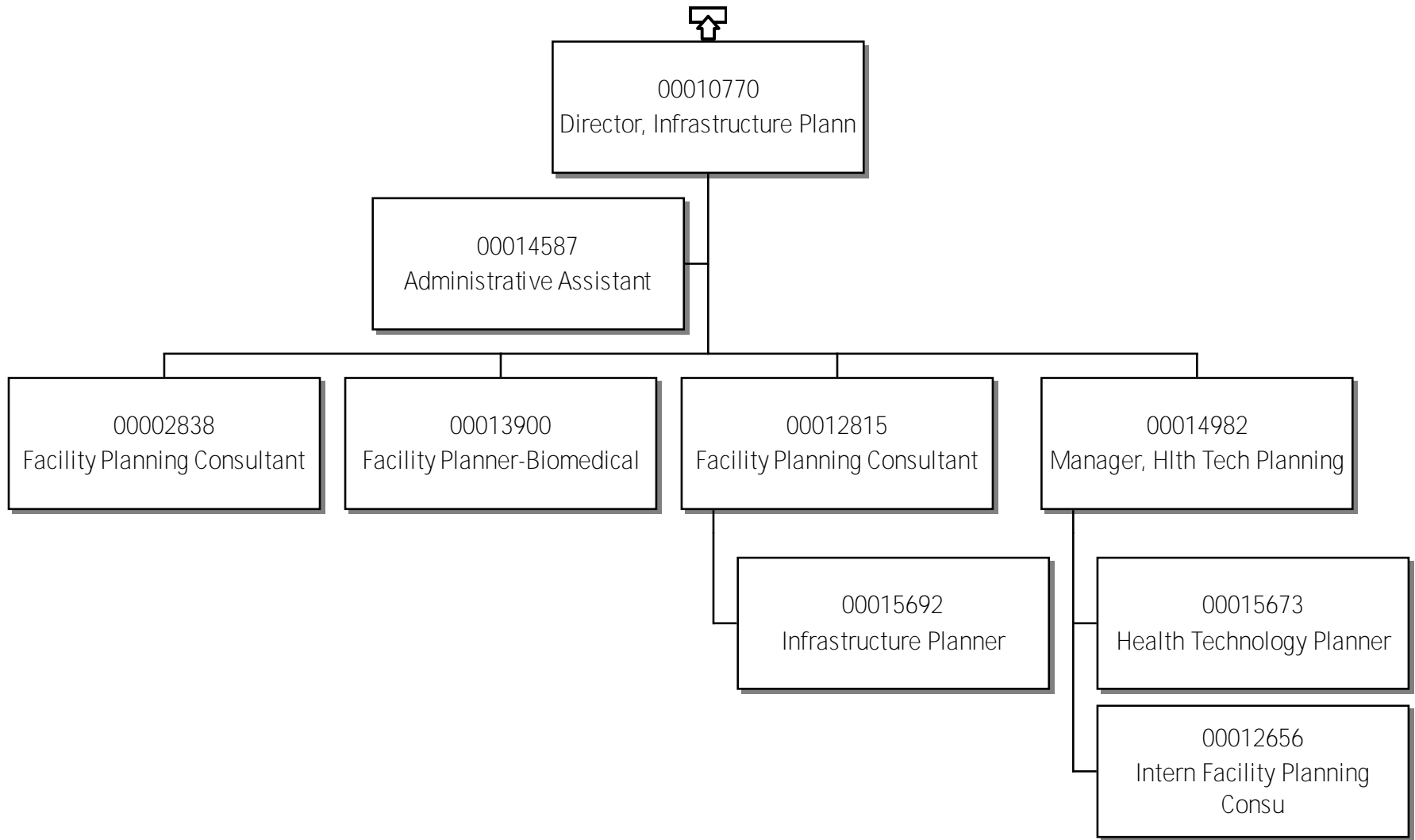

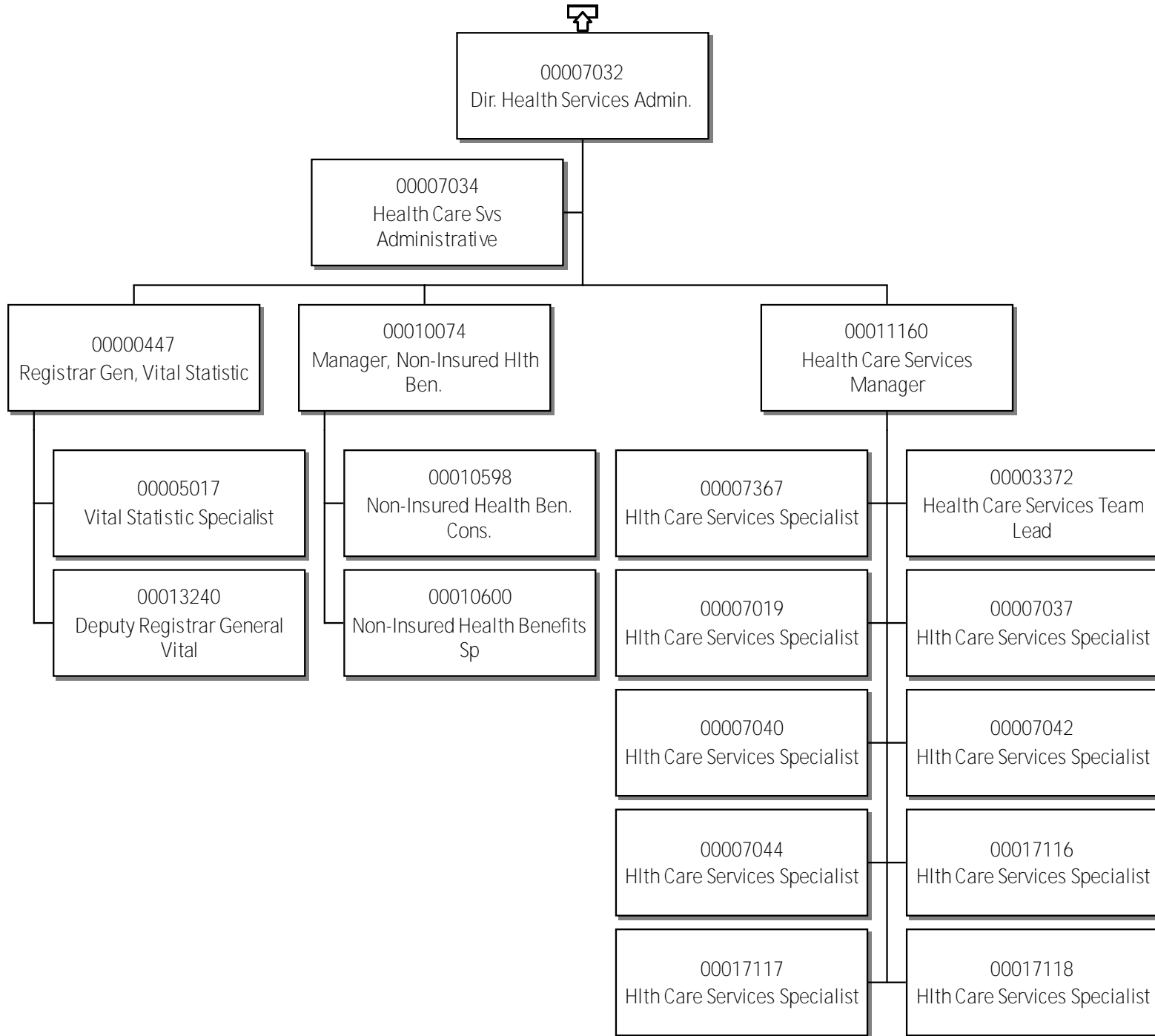

49-Department of Health & Social Services Chief Information Officer

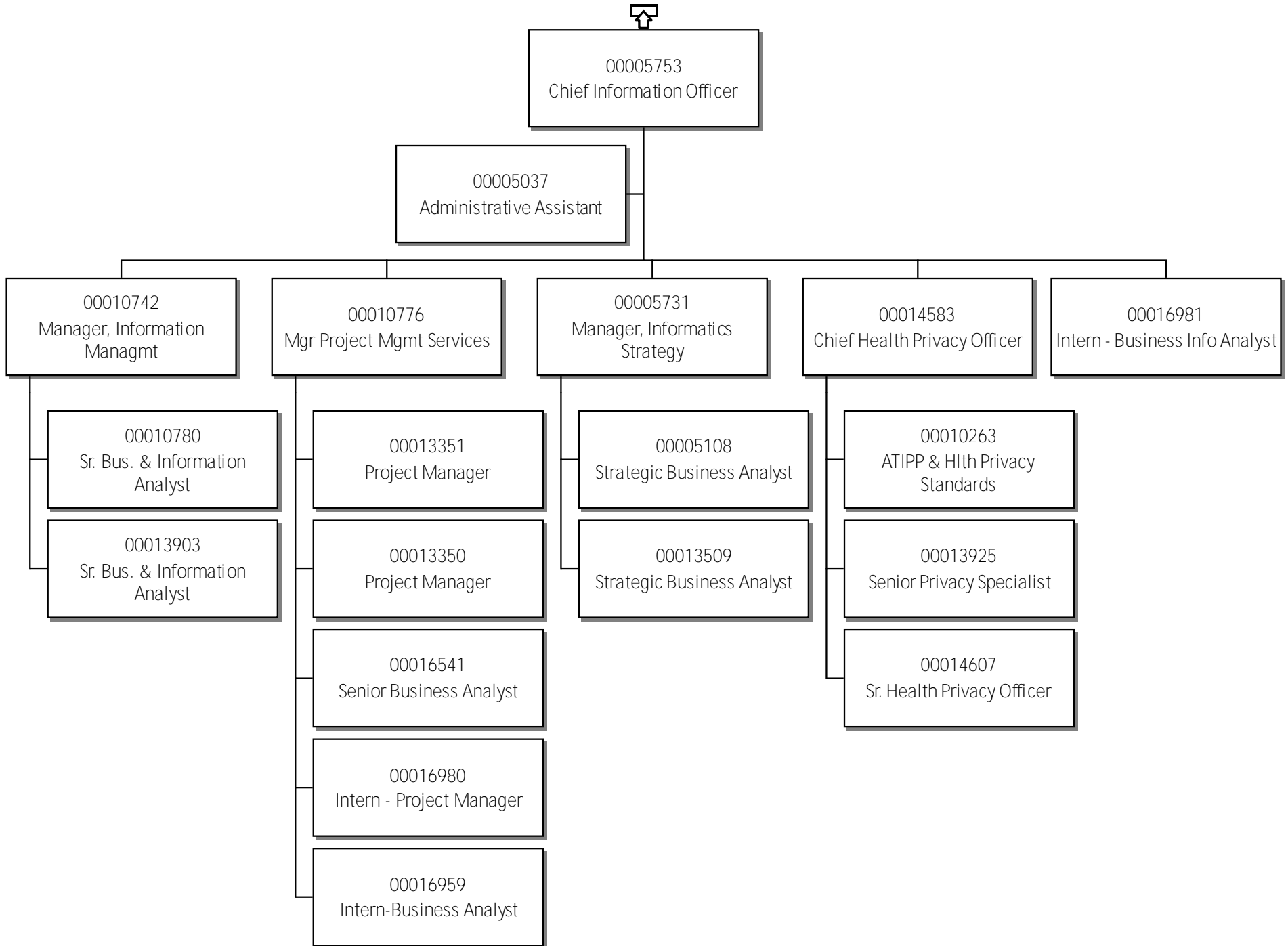

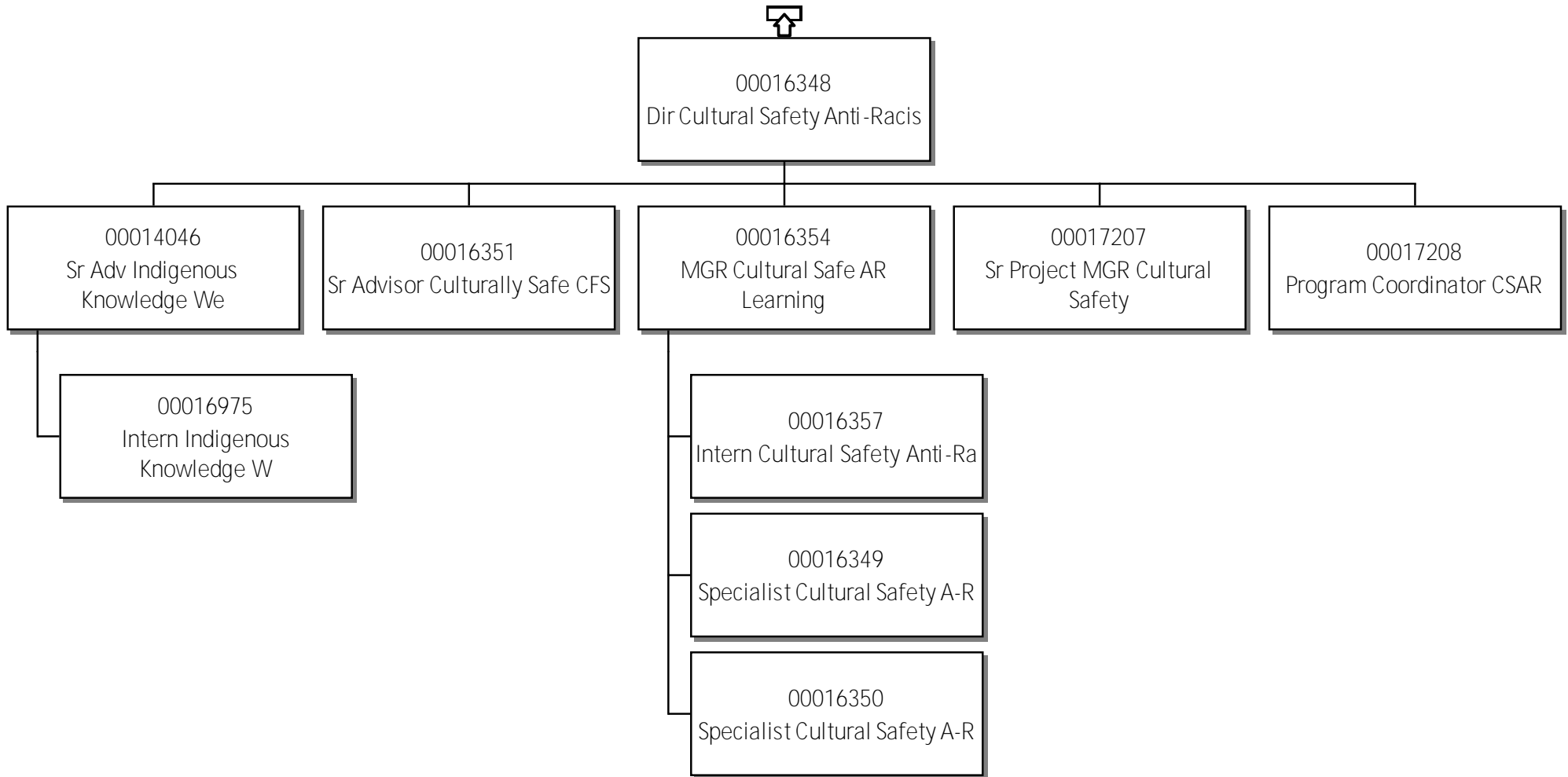

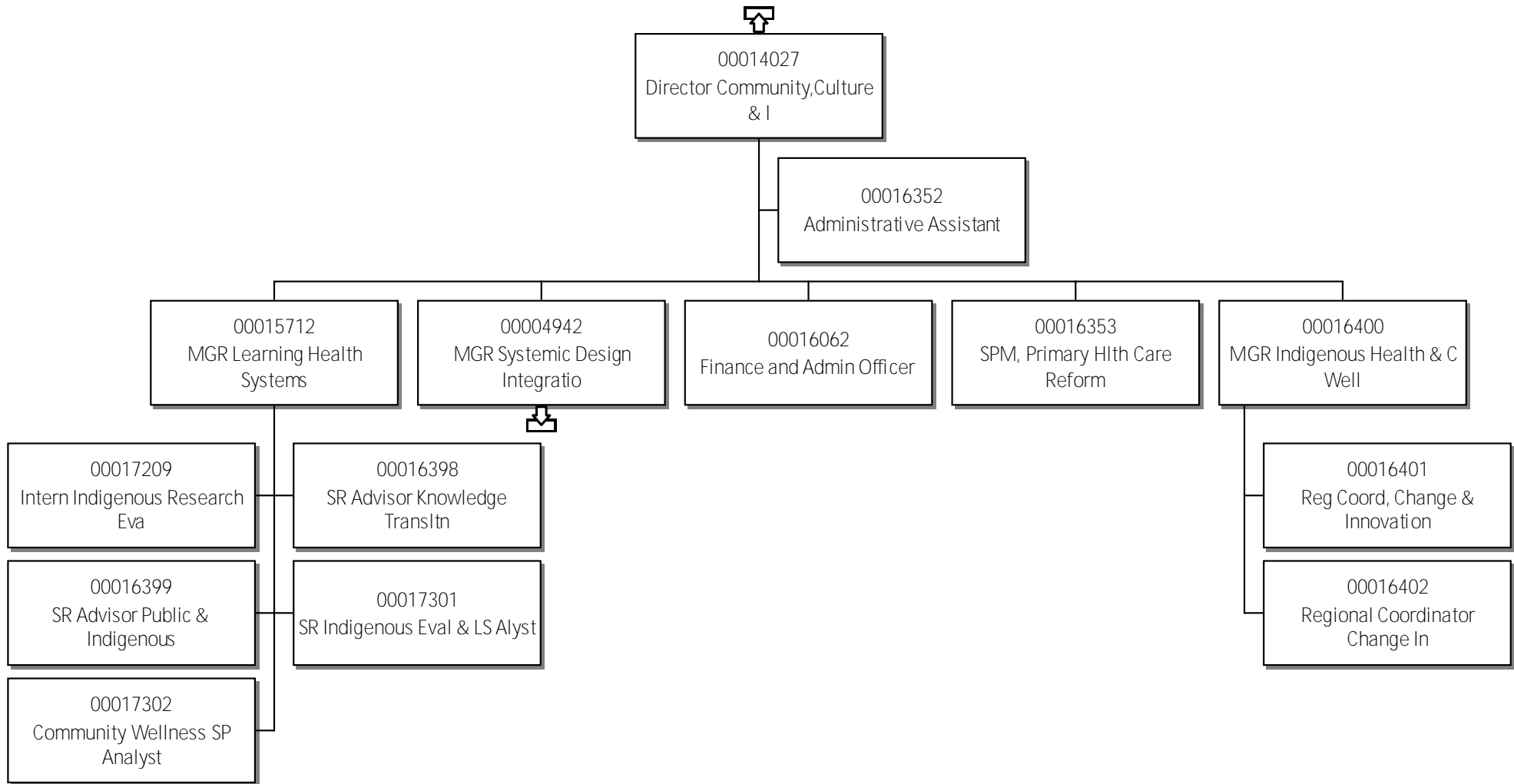

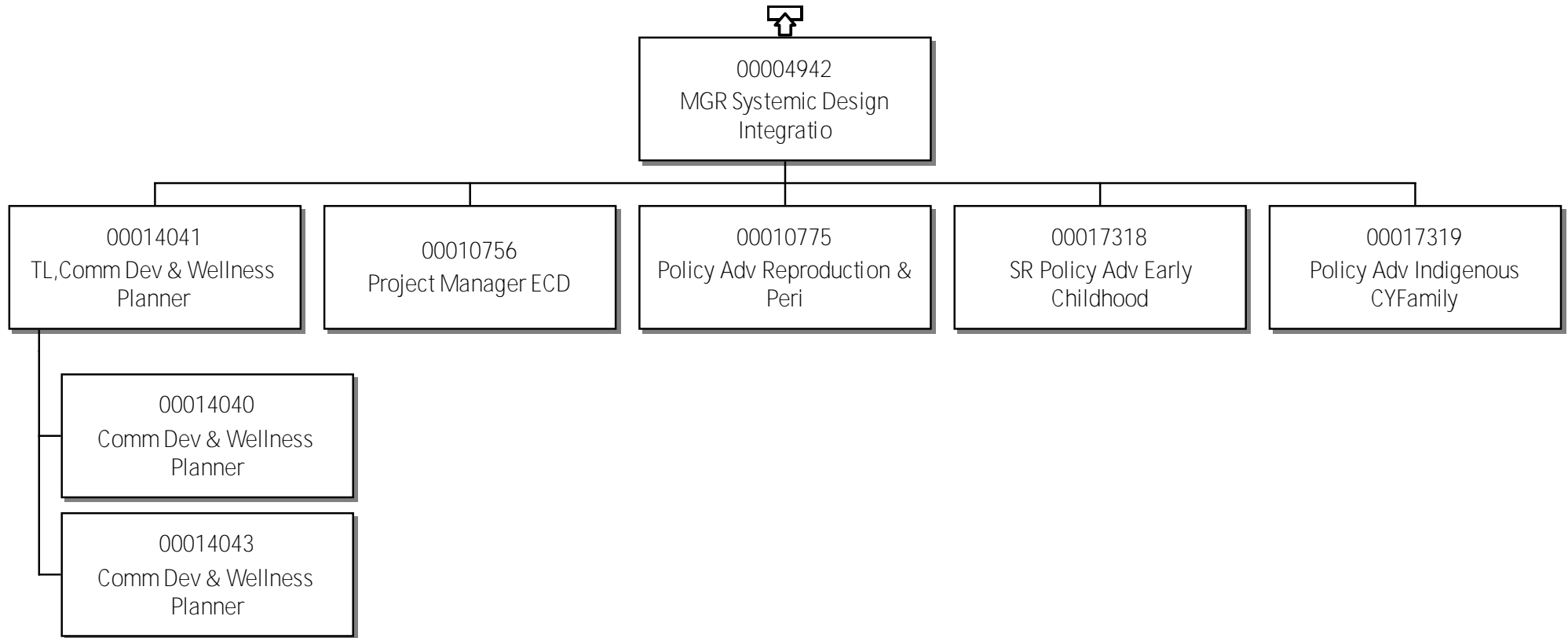

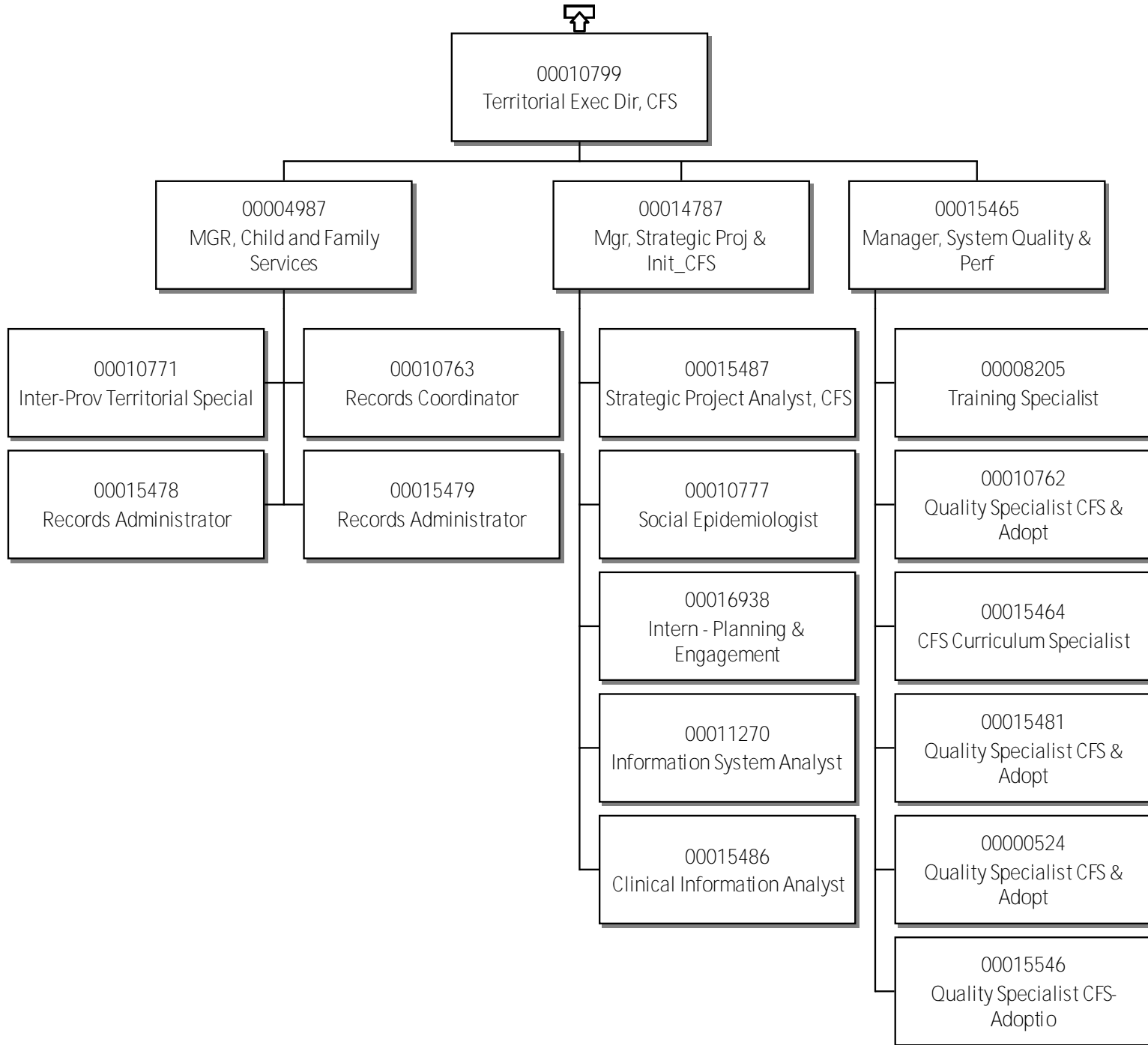

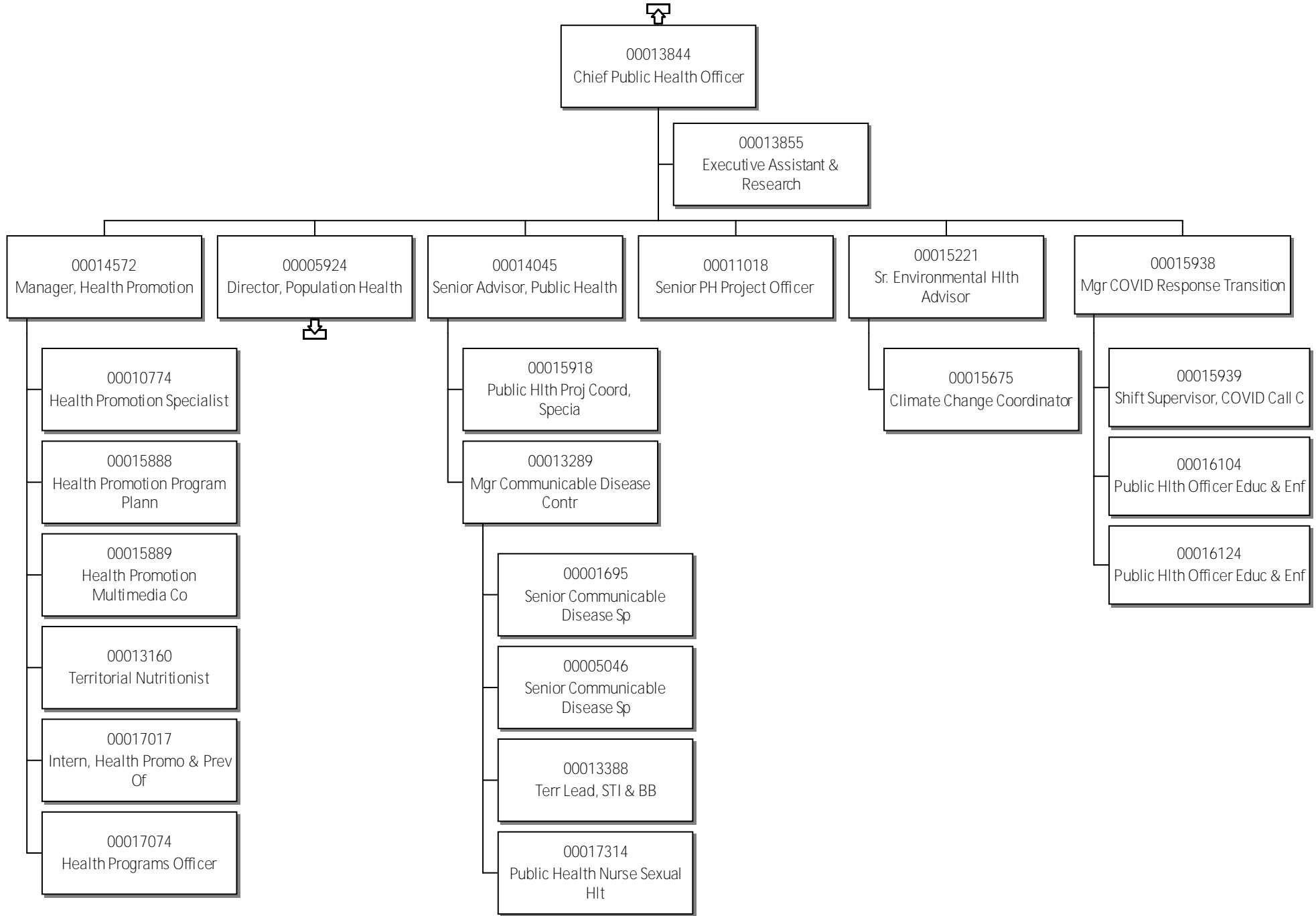

49-Department of Health & Social Services
Director, Population Health

